



ITS TRAPEZOIDAL SHAPE AND SIDE TILTING ANGLES (52°-60°) ENABLE THE REALIZATION AND MAINTENANCE OF DITCHES AND DRAINS OF DIFFERENT SIZES AND ANGLES.



OPTIONAL

- 1 DC TEETH DTE TEETH

MOD.	MIDI							EXCAVATOR			
	T38	T45	T53	T62	T67	T73	T80	T85 GD	T92 GD	T100 GD	T110 GD
TONS (LB)	0,6 - 1,8 (1323 - 3968)	1,8 - 2,5 (2646 - 5512)	2,5 - 4,0 (5512 - 8818)	4,0 - 5,0 (8818 - 11023)	5,0 - 7,5 (11023 - 16535)	7,5 - 10,0 (16535 - 22046)	10,0 - 12,0 (22046 - 26455)	12,0 - 14,0 (26455 - 30865)	12,0 - 14,0 (26455 - 30865)	14,0 - 18,0 (30865 - 39683)	18,0 - 22,0 (39683 - 48502)

T38 MACHINE WEIGHT 0,6 - 1,8 t (1323 - 3968 lb)

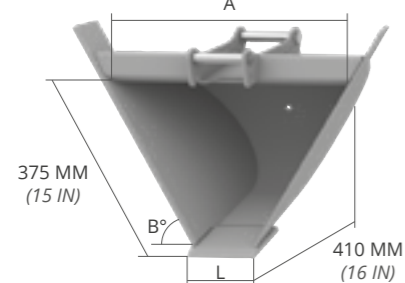

L MM (IN)	A MM (IN)	B°	WEIGHT KG* (LB*)	CAP. SAE L (GAL)	ADAPTERS
200 (8)	607 (23,9)	52°	27 (60)	47 (12,4)	AF - AR - CS
					CR - CM
					CW - CS JANUS PRO
200 (8)	490 (19,3)	60°	24 (53)	37 (9,8)	AF - AR - CS
					CR - CM
					CW - CS JANUS PRO

OPTIONAL

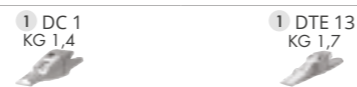

T45 MACHINE WEIGHT 1,8 - 2,5 t (3968 - 5512 lb)

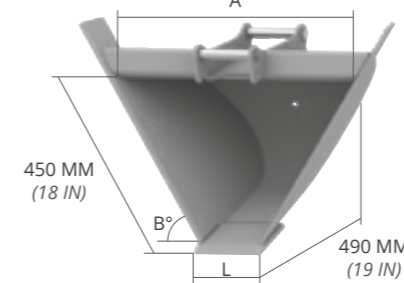
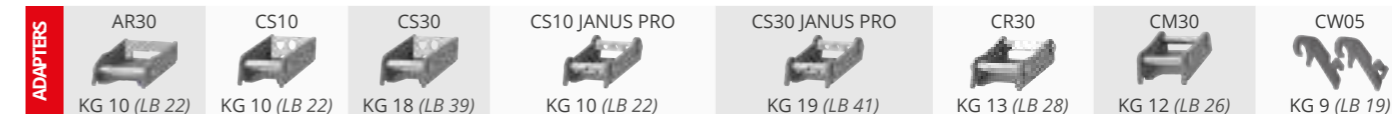

L MM (IN)	A MM (IN)	B°	WEIGHT KG* (LB*)	CAP. SAE L (GAL)	ADAPTERS
250 (10)	741 (29,2)	52°	45 (99)	77 (22,3)	AF - AR - CS
					CR - CM
					CW - CS JANUS PRO
250 (10)	600 (23,6)	60°	40 (88)	63 (16,6)	AF - AR - CS
					CR - CM
					CW - CS JANUS PRO

OPTIONAL



T53 MACHINE WEIGHT 2,5 - 4,0 t (5512 - 8818 lb)

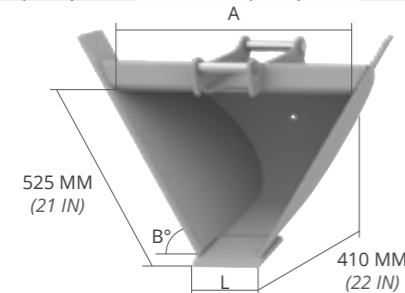
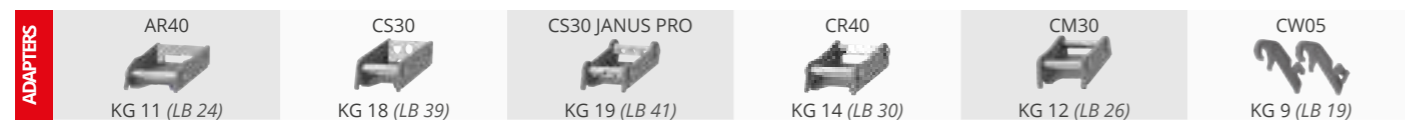

L MM (IN)	A MM (IN)	B°	WEIGHT KG* (LB*)	CAP. SAE L (GAL)	ADAPTERS
300 (12)	868 (34,2)	52°	69 (152)	140 (37,0)	AF - AR - CS
					CR - CM
					CW - CS JANUS PRO
300 (12)	705 (27,8)	60°	61 (134)	114 (30,1)	AF - AR - CS
					CR - CM
					CW - CS JANUS PRO

OPTIONAL

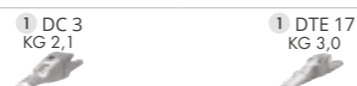

T62 MACHINE WEIGHT 4,0 - 5,0 t (8818 - 11023 lb)

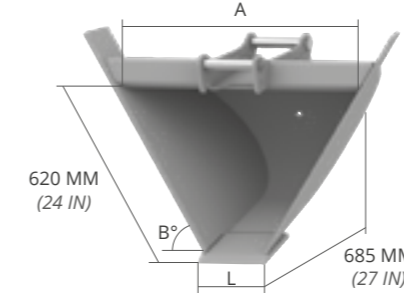
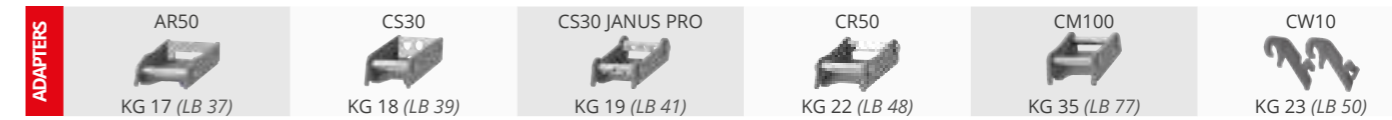

L MM (IN)	A MM (IN)	B°	WEIGHT KG* (LB*)	CAP. SAE L (GAL)	ADAPTERS
300 (12)	985 (38,8)	52°	101 (223)	190 (50,2)	AF - AR - CS
					CR - CM
					CW - CS JANUS PRO
300 (12)	790 (31,1)	60°	88 (194)	153 (40,4)	AF - AR - CS
					CR - CM
					CW - CS JANUS PRO

OPTIONAL



* weight of the tank excluding attachment

* weight of the tank excluding attachment

T67 MACHINE WEIGHT 5,0 - 7,5 t (11023 - 16535 lb)

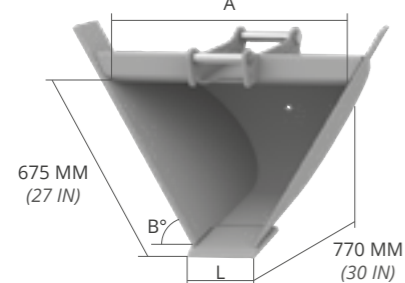

L MM (IN)	A MM (IN)	B°	WEIGHT KG* (LB*)	CAP. SAE L (GAL)	ADAPTERS
350 (14)	1087 (42,8)	52°	144 (317)	239 (63,1)	AF - AR - CS
					CR - CM
					CW - CS JANUS PRO
350 (14)	876 (34,5)	60°	126 (278)	191 (50,5)	AF - AR - CS
					CR - CM
					CW - CS JANUS PRO

OPTIONAL

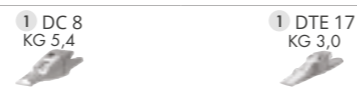

T73 MACHINE WEIGHT 7,5 - 10,0 t (16535 - 22046 lb)

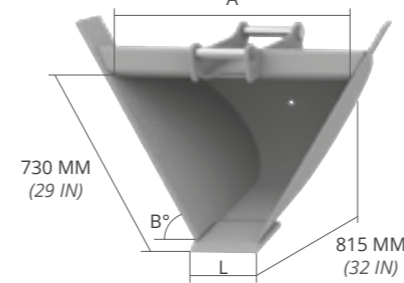
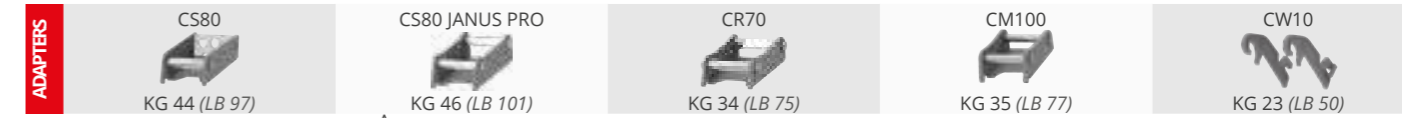

L MM (IN)	A MM (IN)	B°	WEIGHT KG* (LB*)	CAP. SAE L (GAL)	ADAPTERS
350 (14)	1157 (45,6)	52°	166 (366)	318 (84,0)	AF - CS
					CR - CM
					CW - CS JANUS PRO
350 (14)	928 (36,5)	60°	146 (322)	254 (67,1)	AF - CS
					CR - CM
					CW - CS JANUS PRO

OPTIONAL

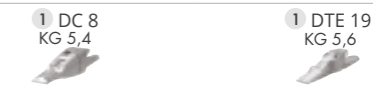

T80 MACHINE WEIGHT 10,0 - 12,0 t (22046 - 26455 lb)

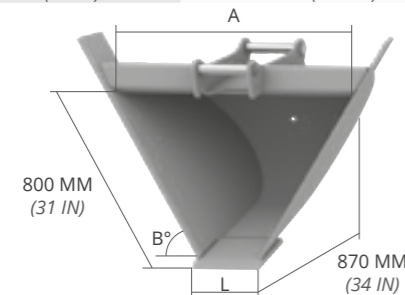

L MM (IN)	A MM (IN)	B°	WEIGHT KG* (LB*)	CAP. SAE L (GAL)	ADAPTERS
350 (14)	1236 (48,7)	52°	207 (456)	355 (93,8)	AF - CS
					CR - CM - CS JANUS PRO
					CW
350 (14)	985 (38,8)	60°	184 (406)	281 (74,2)	AF - CS
					CR - CM - CS JANUS PRO
					CW

OPTIONAL

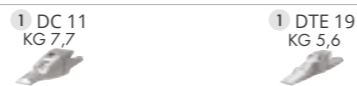

T85 GD MIDI MACHINE WEIGHT 12,0 - 14,0 t (26455 - 30865 lb)

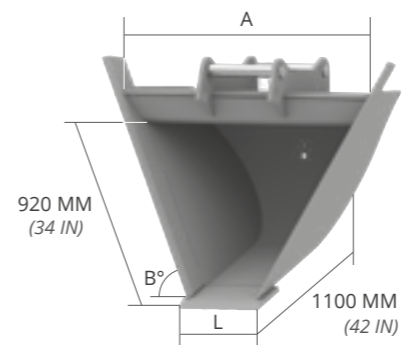
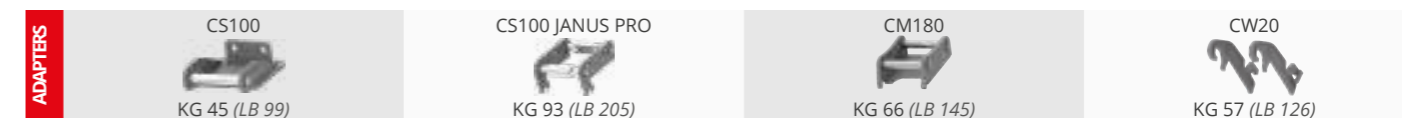

L MM (IN)	A MM (IN)	B°	WEIGHT KG* (LB*)	CAP. SAE L (GAL)	ADAPTERS
350 (14)	1420 (56)	52°	320 (705)	430 (113,6)	AF - CM
					CS - CW
					CS JANUS PRO
350 (14)	1120 (44)	60°	275 (606)	370 (97,7)	AF - CM
					CS - CW
					CS JANUS PRO

OPTIONAL

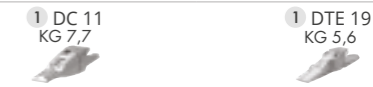

* weight of the tank excluding attachment

* weight of the tank excluding attachment

T92 GD EXCAVATOR MACHINE WEIGHT 12,0 - 14,0 t (26455 - 30865 lb)

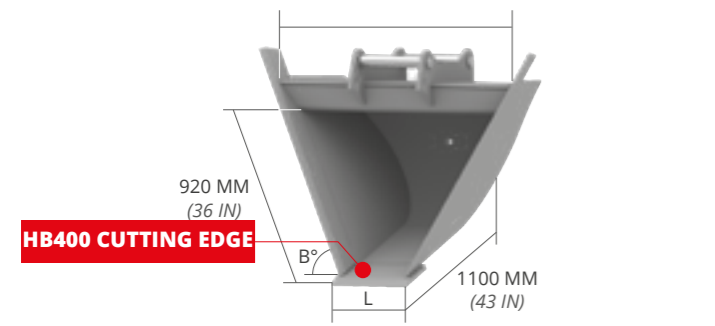
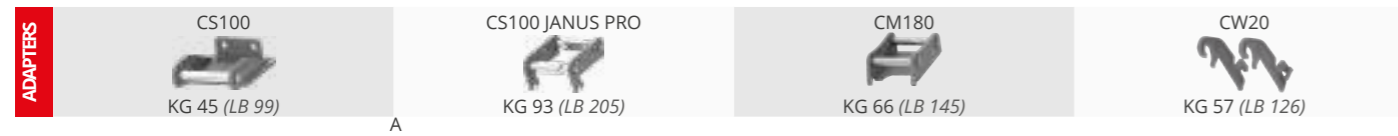

L MM (IN)	A MM (IN)	B°	WEIGHT KG* (LB*)	CAP. SAE L (GAL)	ADAPTERS
400 (16)	1550 (48)	52°	400 (882)	540 (142,7)	AF - CM CS - CW CS JANUS PRO
400 (16)	1230 (48)	60°	340 (750)	470 (124,2)	AF - CM CS - CW CS JANUS PRO

OPTIONAL

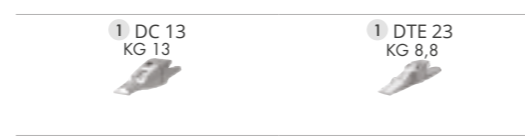

T100 GD MACHINE WEIGHT 14,0 - 18,0 t (30865 - 39683 lb)

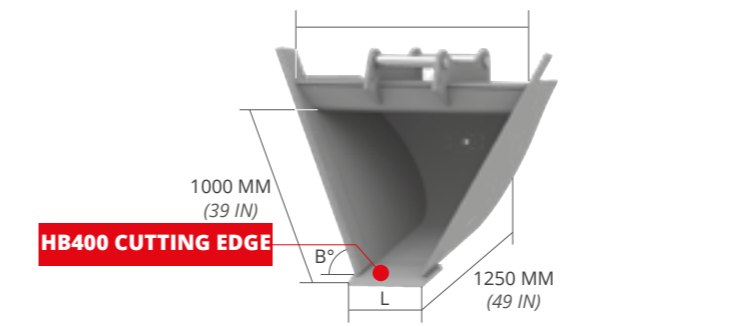
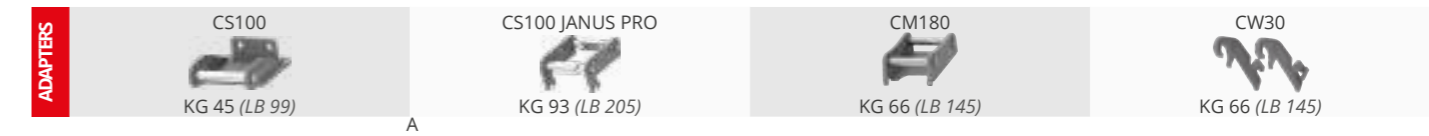

L MM (IN)	A MM (IN)	B°	WEIGHT KG* (LB*)	CAP. SAE L (GAL)	ADAPTERS
400 (16)	1680 (66)	52°	530 (1168)	680 (179,6)	AF - CM CS - CW CS JANUS PRO
400 (16)	1320 (52)	60°	455 (1003)	585 (154,5)	AF - CM CS - CW CS JANUS PRO

OPTIONAL

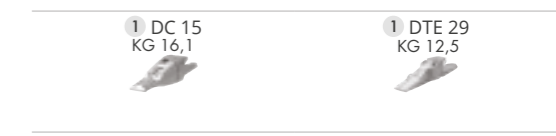

T110 GD MACHINE WEIGHT 18,0 - 22,0 t (39683 - 48502 lb)

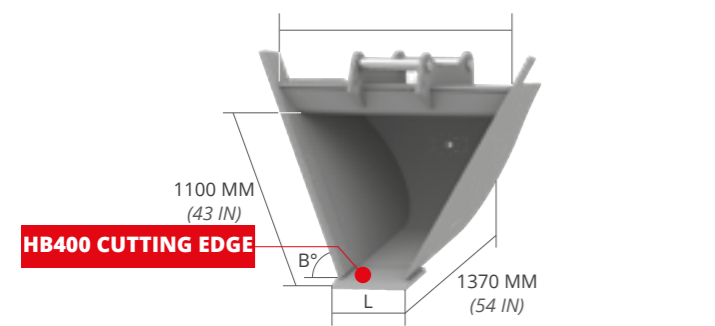
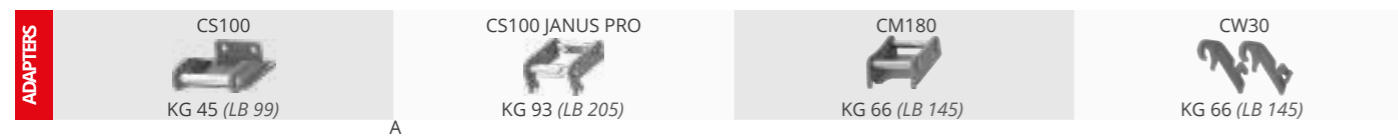

L MM (IN)	A MM (IN)	B°	WEIGHT KG* (LB*)	CAP. SAE L (GAL)	ADAPTERS
400 (16)	1820 (72)	52°	660 (1455)	870 (229,8)	AF - CM CS - CW CS JANUS PRO
400 (16)	1100 (43)	60°	565 (1246)	740 (195,5)	AF - CM CS - CW CS JANUS PRO

OPTIONAL

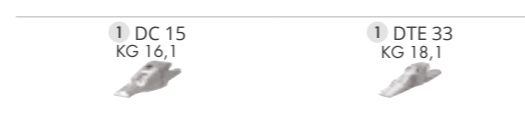

* weight of the tank excluding attachment

* weight of the tank excluding attachment