



HB400 REINFORCEMENTS ON THE AREAS OF MAJOR WEAR, CAST SIDE CUTTERS AND A BOLTED-IN REVERSIBLE UNDERBLADE MAKE THIS BUCKET SUITABLE FOR WORKS ON ABRASIVE SOILS.

THE INSTALLATION OF BEZELS IS HIGHLY RECOMMENDED FOR BUCKETS WIDER THAN 1400 MM, IN ORDER TO AVOID DAMAGES TO THE BUCKET IN CASE OF HEAVY DUTY JOBS OR WITH PARTICULARLY HARD TERRAINS:

- WIDTH FROM 1400 TO 1500 MM: NR. 1 BEZEL
- WIDTH FROM 1600 TO 1600 MM: NR. 2 BEZELS
- WIDTH FROM 1800 TO 2200 MM: NR. 3 BEZELS

MOD.	SPR35	SPR40	SPR40	SPR45	SPR50	SPR55	MIDI	EXCAVATOR	SPR70 HD
TONS (LB)	1,8 - 2,5 (3968 - 5512)	2,0 - 2,5 (4409 - 5512)	2,5 - 4,0 (5512 - 8818)	4,0 - 5,0 (8818 - 11023)	5,0 - 7,5 (11023 - 16535)	7,5 - 10,0 (16535 - 22046)	10,0 - 12,0 (22046 - 26455)	12,0 - 18,0 (26455 - 39683)	18,0 - 22,0 (39683 - 48502)



ADAPTERS

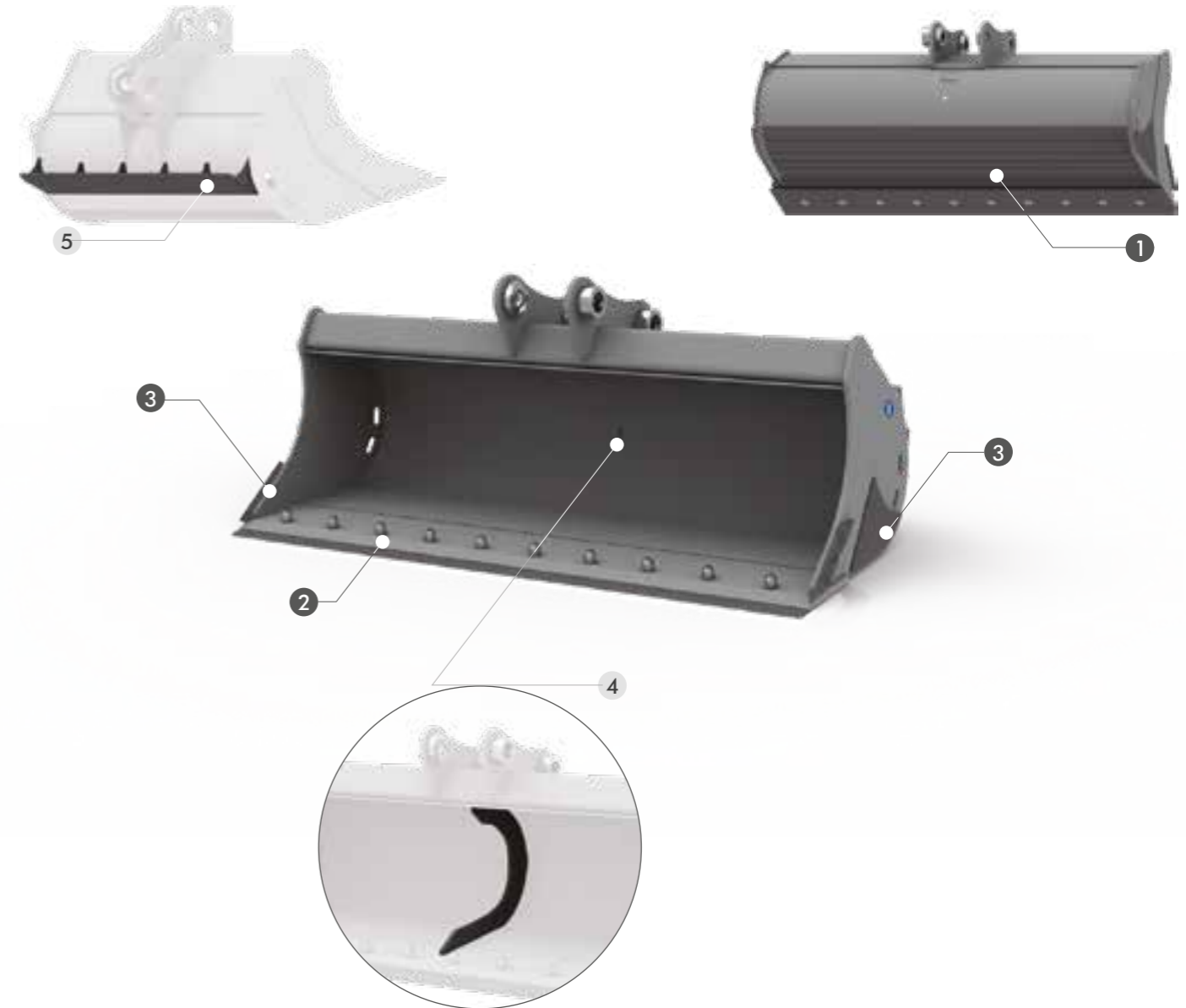

SPECIFICHE TECNICHE STANDARD

- 1 HB400 REINFORCING STRIPS**
THE HORIZONTAL REINFORCING STRIPS ON THE BUCKET'S REAR AND BOTTOM PROTECT THE BUCKET FROM WEAR AND INCREASE ITS RESISTANCE.
- 2 HB400 ADDITIONAL BOLT-ON REVERSIBLE CUTTING EDGE**
HB400 BOLTED-IN REVERSIBLE UNDERBLADE INDICATED TO WORK ON PARTICULARLY ABRASIVE SOILS.
- 3 HB400 SIDE CAST CUTTERS AND REINFORCEMENTS**
THESE HB400 CAST CUTTERS ARE POSITIONED ON THE SURFACES MOSTLY SUBJECT TO WEAR GRANTING A HIGHER RESISTANCE.

OPTIONAL

- 4 BEZEL**
IT ENSURES A HIGHER STRUCTURAL RESISTANCE. **HIGHLY RECOMMENDED WITH BUCKETS 1400MM WIDE OR MORE.**
- 5 REAR RAZOR**
WHEN THE MACHINE'S ARM IS KEPT CLOSED, IT ALLOWS TO FINISH SURFACES EVENLY.

SPR35 MACHINE WEIGHT - 1,2 - 1,8 t (2646 - 3968 lb)

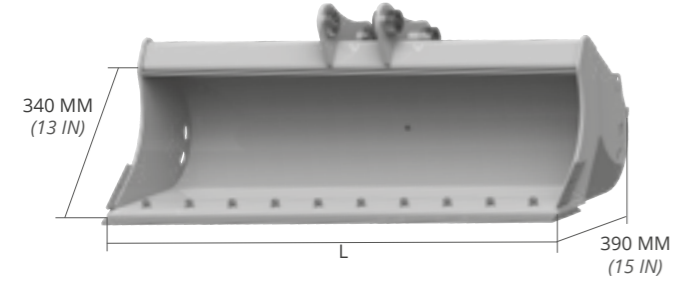
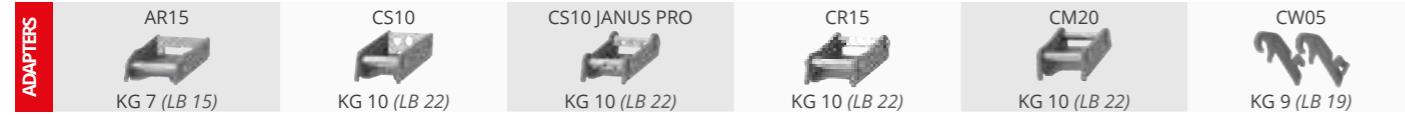

L MM (IN)	WEIGHT KG* (LB*)	CAP. SAE L (GAL)	ADAPTERS
800 (31)	63 (138)	75 (19,8)	AF - AR - CS
			CR - CM
			CW - CS JANUS PRO
1000 (39)	76 (168)	96 (25,4)	AF - AR - CS
			CR - CM
			CW - CS JANUS PRO
1200 (47)	90 (198)	117 (30,9)	AF - AR - CS
			CR - CM
			CW - CS JANUS PRO

OPTIONAL

5
REAR RAZOR

SPR40 MACHINE WEIGHT 2,0 - 2,5 t (4409 - 5511 lb)

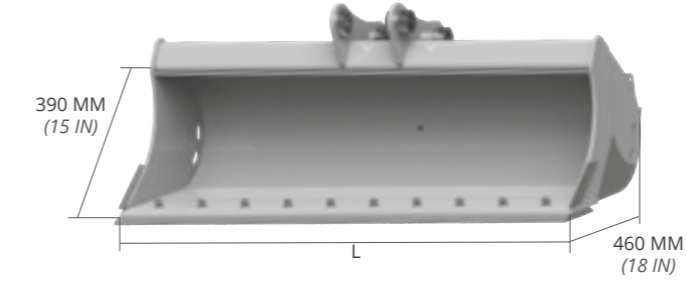

L MM (IN)	WEIGHT KG* (LB*)	CAP. SAE L (GAL)	ADAPTERS
1000 (39)	108 (238)	125 (33,0)	AF - AR - CS
			CR - CM
			CW - CS JANUS PRO
1200 (47)	128 (282)	154 (40,7)	AF - AR - CS
			CR - CM
			CW - CS JANUS PRO

OPTIONAL

4
BEZEL

5
REAR RAZOR

SPR40 MACHINE WEIGHT 2,5 - 4,0 t (5511 - 8818 lb)

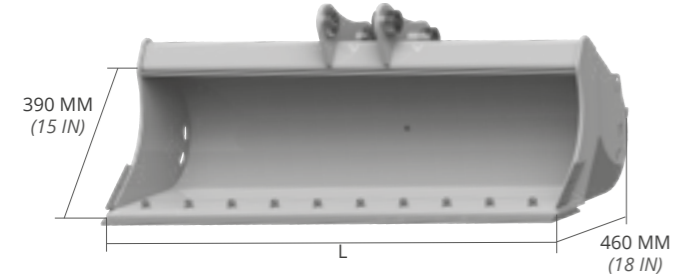
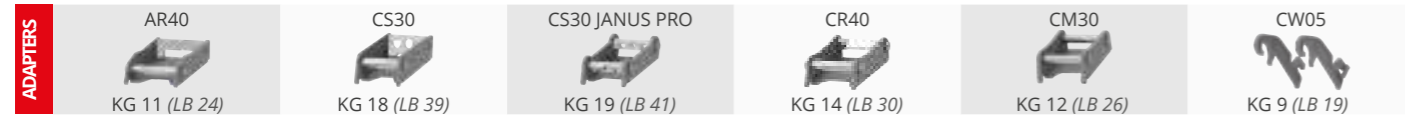

L MM (IN)	WEIGHT KG* (LB*)	CAP. SAE L (GAL)	ADAPTERS
1000 (39)	108 (238)	125 (33,0)	AF - AR - CS
			CR - CM
			CW - CS JANUS PRO
1200 (47)	128 (282)	154 (40,7)	AF - AR - CS
			CR - CM
			CW - CS JANUS PRO
1400 (55)	148 (326)	182 (48,1)	AF - AR - CS
			CR - CM
			CW - CS JANUS PRO

OPTIONAL

4
BEZEL

5
REAR RAZOR

SPR45 MACHINE WEIGHT 4,0 - 5,0 t (8818 - 11023 lb)

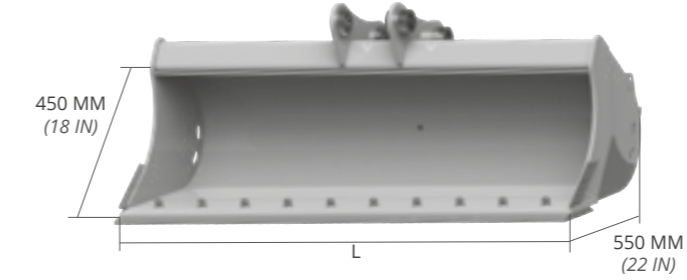
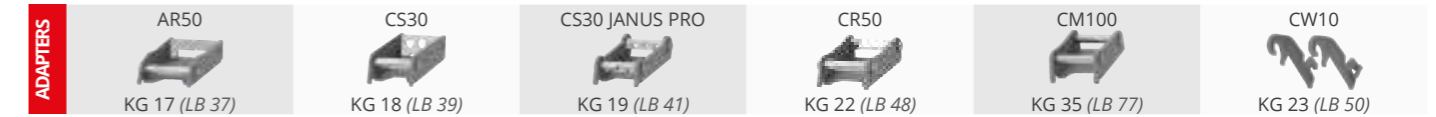

L MM (IN)	WEIGHT KG* (LB*)	CAP. SAE L (GAL)	ADAPTERS
1200 (47)	160 (353)	213 (56,3)	AF - AR - CS
			CR - CM
			CW - CS JANUS PRO
1400 (55)	185 (407)	254 (67,1)	AF - AR - CS
			CR - CM
			CW - CS JANUS PRO
1500 (59)	197 (433)	274 (72,4)	AF - AR - CS
			CR - CM
			CW - CS JANUS PRO

OPTIONAL

4
BEZEL

5
REAR RAZOR

* weight of the tank excluding attachment

* weight of the tank excluding attachment

SPR50 MACHINE WEIGHT 5,0 - 7,5 t (11012 - 16535 lb)

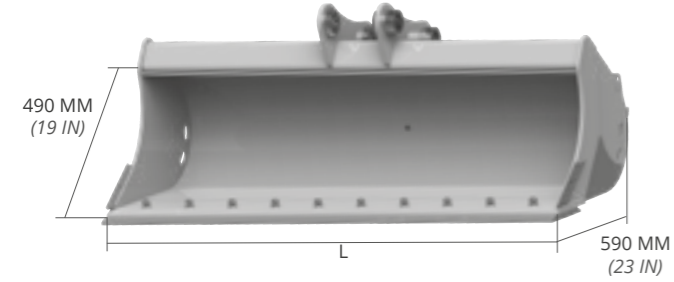
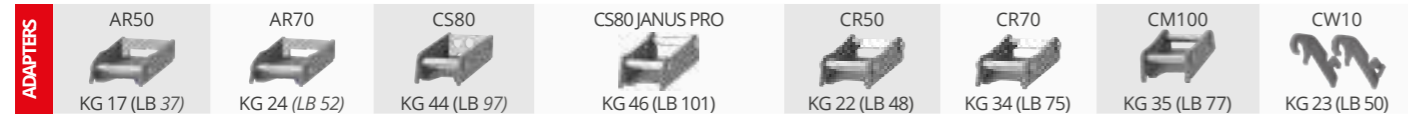

L MM (IN)	WEIGHT KG* (LB*)	CAP. SAE L (GAL)	ADAPTERS
1200 (47)	183 (404)	250 (66,0)	AF - AR - CS
			CR - CM
			CW - CS JANUS PRO
1400 (55)	211 (465)	298 (78,8)	AF - AR - CS
			CR - CM
			CW - CS JANUS PRO
1600 (63)	239 (526)	345 (91,1)	AF - AR - CS
			CR - CM
			CW - CS JANUS PRO
1800 (71)	266 (587)	392 (103,6)	AF - AR - CS
			CR - CM
			CW - CS JANUS PRO

OPTIONAL

- 4 BEZEL
- 5 REAR RAZOR

SPR55 MACHINE WEIGHT 7,5 - 10,0 t (16535 - 22046 lb)

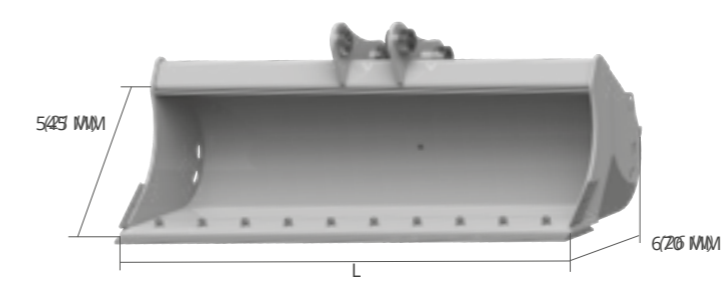

L MM (IN)	WEIGHT KG* (LB*)	CAP. SAE L (GAL)	ADAPTERS
1200 (47)	233 (515)	326 (86,1)	AF - CS
			CR - CM
			CW - CS JANUS PRO
1400 (55)	267 (588)	387 (102,2)	AF - CS
			CR - CM
			CW - CS JANUS PRO
1600 (63)	302 (665)	447 (118,1)	AF - CS
			CR - CM
			CW - CS JANUS PRO
1800 (71)	336 (741)	507 (133,9)	AF - CS
			CR - CM
			CW - CS JANUS PRO

OPTIONAL

- 4 BEZEL
- 5 REAR RAZOR

SPR60 MIDI MACHINE WEIGHT 10,0 - 12,0 t (22046 - 26455 lb)

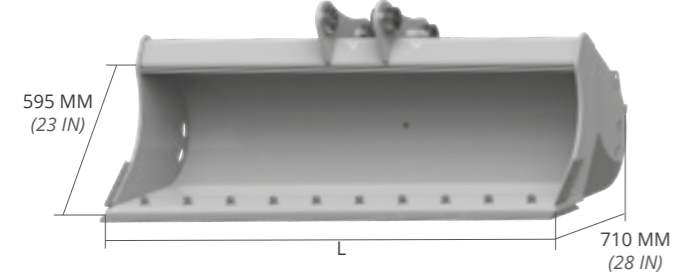

L MM (IN)	WEIGHT KG* (LB*)	CAP. SAE L (GAL)	ADAPTERS
1200 (47)	273 (601)	367 (97,0)	AF - CS
			CR - CM - CS JANUS PRO
			CW
1400 (55)	311 (685)	436 (115,2)	AF - CS
			CR - CM - CS JANUS PRO
			CW
1600 (63)	351 (774)	504 (133,1)	AF - CS
			CR - CM - CS JANUS PRO
			CW
1800 (71)	389 (858)	573 (151,4)	AF - CS
			CR - CM - CS JANUS PRO
			CW
2000 (79)	427 (942)	641 (169,3)	AF - CS
			CR - CM - CS JANUS PRO
			CW

OPTIONAL

- 4 BEZEL
- 5 REAR RAZOR

SPR65 HD EXCAVATOR MACHINE WEIGHT 12,0 - 18,0 t (26455 - 39683 lb)

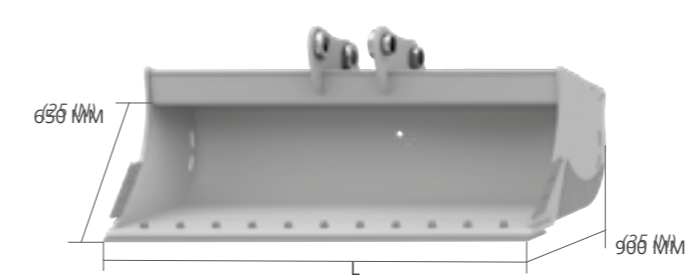

L MM (IN)	WEIGHT KG* (LB*)	CAP. SAE L (GAL)	ADAPTERS
1400 (55)	394 (869)	631 (166,7)	AF - CM
			CS - CW
			CS JANUS PRO
1500 (59)	4420 (926)	665 (175,7)	AF - CM
			CS - CW
			CS JANUS PRO
1600 (63)	445 (981)	699 (184,7)	AF - CM
			CS - CW
			CS JANUS PRO
1800 (71)	496 (1093)	767 (202,6)	AF - CM
			CS - CW
			CS JANUS PRO
2000 (79)	546 (1204)	835 (220,6)	AF - CM
			CS - CW
			CS JANUS PRO

OPTIONAL

- 4 BEZEL
- 5 REAR RAZOR

* weight of the tank excluding attachment

* weight of the tank excluding attachment

SPR70 HD MACHINE WEIGHT 18,0 - 22,0 t (39683 - 48502 lb)

ADAPTERS	CS100 KG 45 (LB 99)	CS100 JANUS PRO KG 93 (LB 205)	CM180 KG 66 (LB 145)	CW30 KG 66 (LB 145)
----------	------------------------	-----------------------------------	-------------------------	------------------------

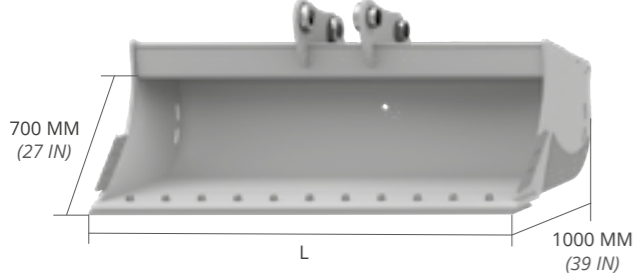

L MM (IN)	WEIGHT KG* (LB*)	CAP. SAE L (GAL)	ADAPTERS
1500 (59)	512 (1130)	780 (206,1)	AF - CM
			CS - CW
			CS JANUS PRO
1600 (63)	543 (1197)	820 (216,6)	AF - CM
			CS - CW
			CS JANUS PRO
1800 (71)	604 (1331)	900 (237,8)	AF - CM
			CS - CW
			CS JANUS PRO
2000 (79)	662 (1460)	980 (258,9)	AF - CM
			CS - CW
			CS JANUS PRO
2200 (87)	719 (1586)	1060 (280,0)	AF - CM
			CS - CW
			CS JANUS PRO

OPTIONAL

- 4 BEZEL
- 5 REAR RAZOR



* weight of the tank excluding attachment